

DTD LED BARN LIGHT

Installation Guide



WARNING

PLEASE READ ALL INSTRUCTIONS BEFORE ATTEMPTING INSTALLATION

- To prevent personal injury or product damage only licensed electricians should install.
- To avoid electric shock or component damage disconnect power before attempting installation or servicing.
- Disconnect product and allow cooling prior to servicing.
- Any alteration or modification of this product is forbidden as it may cause personal injury, death, property damage and/or product malfunction.
- To prevent product malfunction and/or electrical shock this product must be properly grounded.
- This luminaire is designed to operate in ambient temperatures ranging from -40°C to 50°C (-40°F to 122°F).
- MIN 75°C SUPPLY CONDUCTORS.
- CONSULT A QUALIFIED ELECTRICIAN TO ENSURE CORRECT BRANCH CIRCUIT CONDUCTOR.

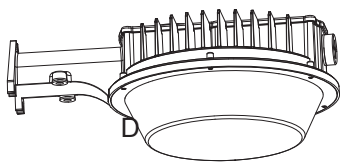

DTD LED BARN LIGHT

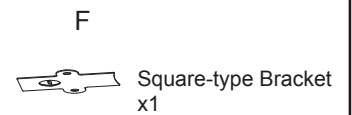
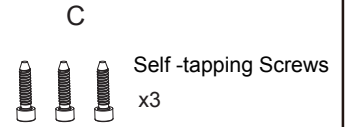
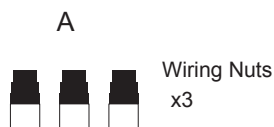

Pole Mounting

1. Select desired CCT & Power and DC photosensor before installation. Screw back the Cap after CCT & Power selection.
2. Remove Bar-type Bracket.
3. Feed wires through the lamp-post, then wire to line voltage.
4. Mount lamp body to pole, and attach the bar-type bracket firmly with screws.
5. Drill holes on the wall, and put in plastic setscrews.
6. Place the self-tapping screws into holes on the mounting bracket, line up with holes in wall and secure firmly with screws.
7. Installation completed.

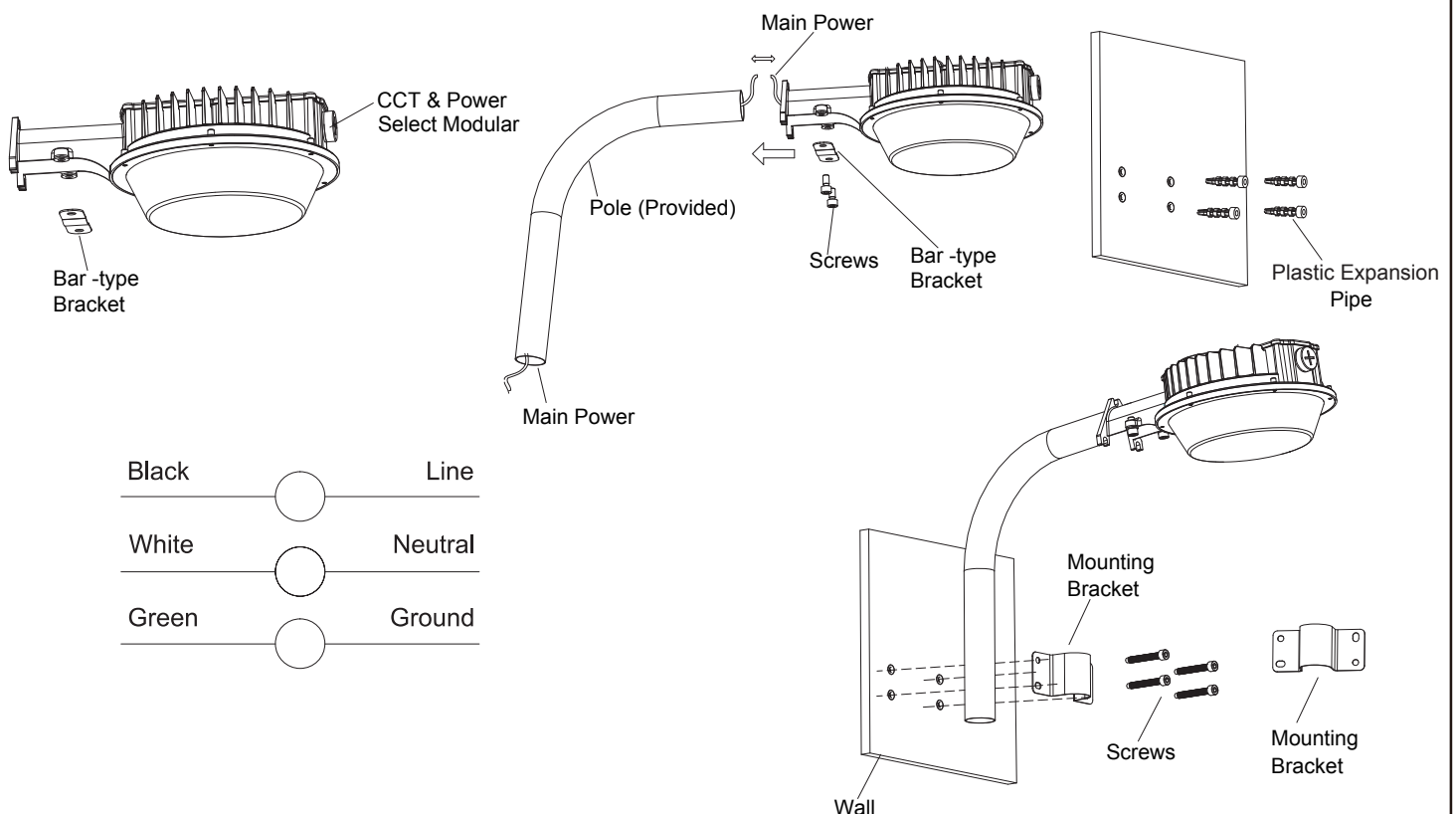

Wall Mounting

1. Select desired CCT & Power and DC photosensor before installation. Screw back the Cap after CCT & Power selection.
2. Remove Square-type Bracket.
3. Place the self-tapping screws into holes on mounting bracket, line up with holes on the wall and attach firmly with screws.
4. Remove knockout from Square-type Bracket, and feed the metal pipe into the bracket.
5. Feed wires through the Square-type Bracket and attach firmly to the luminaire.
6. Installation completed.

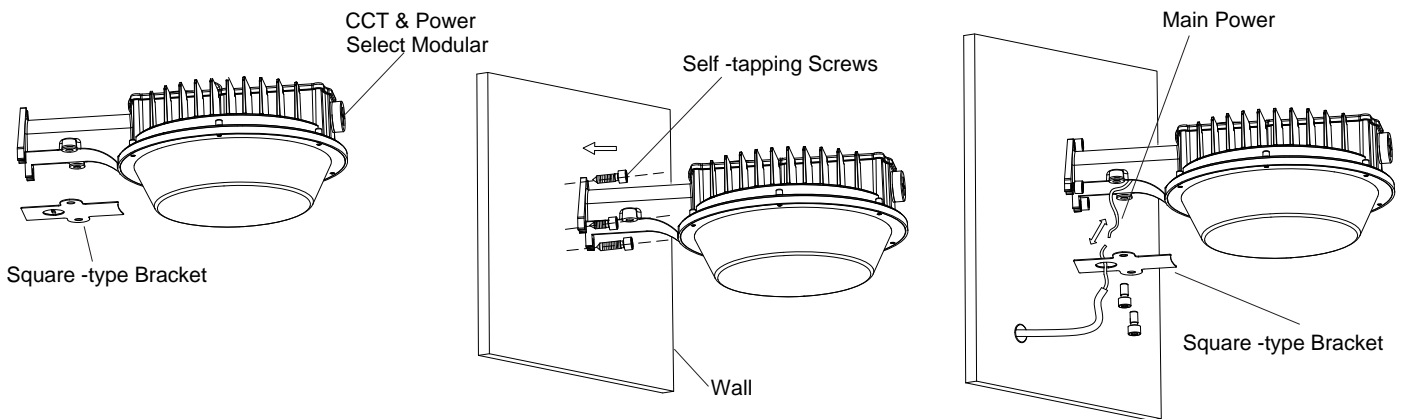

Wiring Diagram

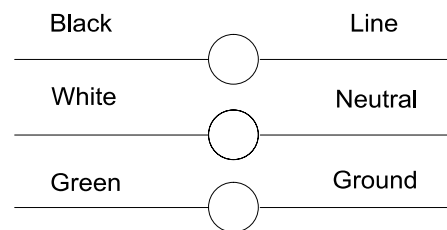

CCT & Power Select Guidance

Warning:

1. Select desired CCT & Power before operation!
2. Cap must be screwed back after CCT & Power selection!

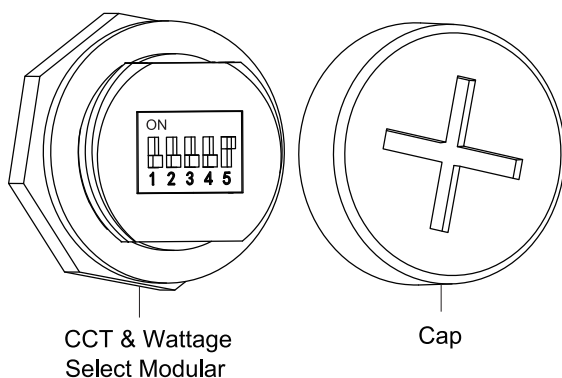

Wattage Select

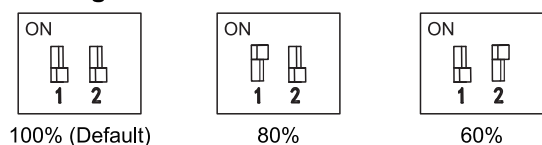

Photocell

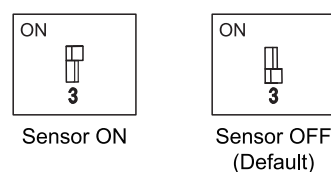

CCT Select

